

Department of Electrical Engineering  
University of Arkansas



# **ELEG 3124 SYSTEMS AND SIGNALS**

## **Ch. 3 Laplace Transform**

---

**Dr. Jingxian Wu**  
**wuj@uark.edu**

# OUTLINE

---

- **Introduction**
- **Laplace Transform**
- **Properties of Laplace Transform**
- **Inverse Laplace Transform**
- **Applications of Laplace Transform**

# INTRODUCTION

---

- **Why Laplace transform?**

- Frequency domain analysis with Fourier transform is extremely useful for the studies of signals and LTI system.

- Convolution in time domain → Multiplication in frequency domain.

- Problem: many signals do not have Fourier transform

$$x(t) = \exp(at)u(t), a > 0$$

$$x(t) = tu(t)$$

- Laplace transform can solve this problem

- It exists for most common signals.

- Follow similar property to Fourier transform

- It doesn't have any physical meaning; just a mathematical tool to facilitate analysis.

- Fourier transform gives us the frequency domain representation of signal.

# OUTLINE

---

- Introduction
- **Laplace Transform**
- Properties of Laplace Transform
- Inverse Laplace Transform
- Applications of Fourier Transform

# LAPLACE TRANSFORM: BILATERAL LAPLACE TRANSFORM

- **Bilateral Laplace transform (two-sided Laplace transform)**

$$X_B(s) = \int_{-\infty}^{+\infty} x(t) \exp(-st) dt, \quad s = \sigma + j\omega$$

- $s = \sigma + j\omega$  is a complex variable
- $s$  is often called the complex frequency
- Notations:

$$X_B(s) = L[x(t)]$$

$$x(t) \leftrightarrow X_B(s)$$

- **Time domain v.s. S-domain**

- $x(t)$  : a function of time  $t \rightarrow x(t)$  is called the time domain signal
- $X_B(s)$  : a function of  $s \rightarrow X_B(s)$  is called the s-domain signal
  - S-domain is also called as the complex frequency domain

# LAPLACE TRANSFORM

---

- **Time domain v.s. s-domain**

- $x(t)$ : a function of time  $t \rightarrow x(t)$  is called the time domain signal
- $X_B(s)$ : a function of  $s \rightarrow X_B(s)$  is called the s-domain signal
  - S-domain is also called the **complex frequency domain**
- By converting the time domain signal into the  $s$ -domain, we can usually greatly simplify the analysis of the LTI system.
- S-domain system analysis:
  - 1. Convert the time domain signals to the s-domain with the Laplace transform
  - 2. Perform system analysis in the s-domain
  - 3. Convert the s-domain results back to the time-domain

# LAPLACE TRANSFORM: BILATERAL LAPLACE TRANSFORM

---

- **Example**

- Find the Bilateral Laplace transform of  $x(t) = \exp(-at)u(t)$

- **Region of Convergence (ROC)**

- The range of  $s$  that the Laplace transform of a signal converges.
- The Laplace transform **always** contains two components
  - The mathematical expression of Laplace transform
  - **ROC.**

# LAPLACE TRANSFORM: BILATERAL LAPLACE TRANSFORM

- **Example**

- Find the Laplace transform of  $x(t) = -\exp(-at)u(-t)$

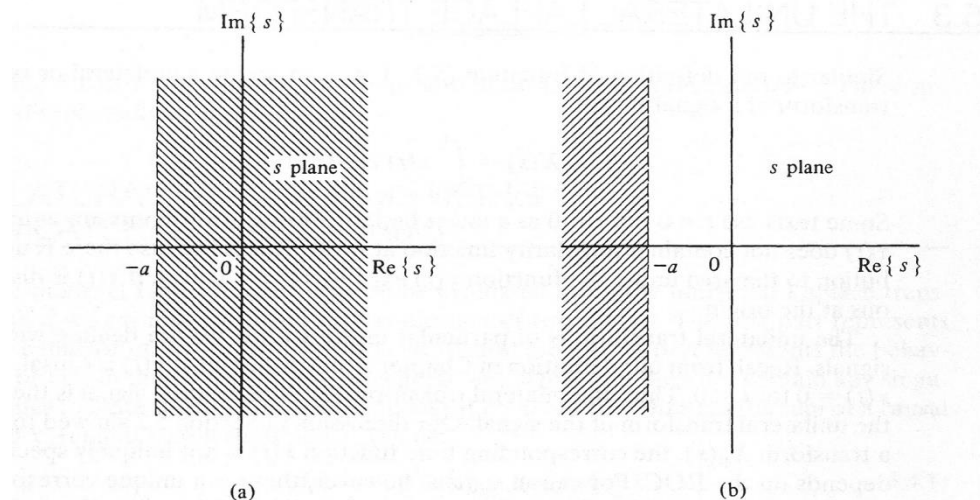

$$X_B(s) = \frac{1}{s+a}, \operatorname{Re}(s) > -a$$

$$X_B(s) = \frac{1}{s+a}, \operatorname{Re}(s) < -a$$



# LAPLACE TRANSFORM: BILATERAL LAPLACE TRANSFORM

---

- **Example**

- Find the Laplace transform of  $x(t) = 3\exp(-2t)u(t) + 4\exp(t)u(-t)$

# LAPLACE TRANSFORM: UNILATERAL LAPLACE TRANSFORM

---

- **Unilateral Laplace transform (one-sided Laplace transform)**

$$X(s) = \int_{0^-}^{+\infty} x(t) \exp(-st) dt$$

- $0^-$  :The value of  $x(t)$  at  $t = 0$  is considered.
- Useful when we dealing with causal signals or causal systems.
  - Causal signal:  $x(t) = 0, t < 0$ .
  - Causal system:  $h(t) = 0, t < 0$ .
- We are going to simply call unilateral Laplace transform as Laplace transform.

# LAPLACE TRANSFORM: UNILATERAL LAPLACE TRANSFORM

---

- **Example: find the unilateral Laplace transform of the following signals.**

- 1.  $x(t) = A$

- 2.  $x(t) = \delta(t)$

# LAPLACE TRANSFORM: UNILATERAL LAPLACE TRANSFORM

---

- **Example**

- 3.  $x(t) = \exp(j2t)$

- 4.  $x(t) = \cos(2t)$

- 5.  $x(t) = \sin(2t)$

# LAPLACE TRANSFORM: UNILATERAL LAPLACE TRANSFORM

Signal	Transform	ROC
1. $u(t)$	$\frac{1}{s}$	$\text{Re}\{s\} > 0$
2. $u(t) - u(t - a)$	$\frac{1 - \exp[-as]}{s}$	$\text{Re}\{s\} > 0$
3. $\delta(t)$	1	for all $s$
4. $\delta(t - a)$	$\exp[-as]$	for all $s$
5. $t^n u(t)$	$\frac{n!}{s^{n+1}}, \quad n = 1, 2, \dots$	$\text{Re}\{s\} > 0$
6. $\exp[-at]u(t)$	$\frac{1}{s + a}$	$\text{Re}\{s\} > -a$
7. $t^n \exp[-at]u(t)$	$\frac{n!}{(s + a)^{n+1}}$	$\text{Re}\{s\} > -a$
8. $\cos \omega_0 t u(t)$	$\frac{s}{s^2 + \omega_0^2}$	$\text{Re}\{s\} > 0$
9. $\sin \omega_0 t u(t)$	$\frac{\omega_0}{s^2 + \omega_0^2}$	$\text{Re}\{s\} > 0$
10. $\cos^2 \omega_0 t u(t)$	$\frac{s^2 + 2\omega_0^2}{s(s^2 + 4\omega_0^2)}$	$\text{Re}\{s\} > 0$
11. $\sin^2 \omega_0 t u(t)$	$\frac{2\omega_0^2}{s(s^2 + 4\omega_0^2)}$	$\text{Re}\{s\} > 0$
12. $\exp[-at] \cos \omega_0 t u(t)$	$\frac{s + a}{(s + a)^2 + \omega_0^2}$	$\text{Re}\{s\} > -a$
13. $\exp[-at] \sin \omega_0 t u(t)$	$\frac{\omega_0}{(s + a)^2 + \omega_0^2}$	$\text{Re}\{s\} > -a$
14. $t \cos \omega_0 t u(t)$	$\frac{s^2 - \omega_0^2}{(s^2 + \omega_0^2)^2}$	$\text{Re}\{s\} > 0$
15. $t \sin \omega_0 t u(t)$	$\frac{2\omega_0 s}{(s^2 + \omega_0^2)^2}$	$\text{Re}\{s\} > 0$

# OUTLINE

---

- Introduction
- Laplace Transform
- **Properties of Laplace Transform**
- Inverse Laplace Transform
- Applications of Fourier Transform

# PROPERTIES: LINEARITY

---

- **Linearity**

- If  $x_1(t) \leftrightarrow X_1(s)$        $x_2(t) \leftrightarrow X_2(s)$

- Then  $ax_1(t) + bx_2(t) \leftrightarrow aX_1(s) + bX_2(s)$

The ROC is the intersection between the two original signals

- **Example**

- Find the Laplace transform of  $[A + B \exp(-bt)]u(t)$

# PROPERTIES: TIME SHIFTING

---

- **Time shifting**

- If  $x(t) \leftrightarrow X(s)$  and  $t_0 > 0$

- Then  $x(t - t_0)u(t - t_0) \leftrightarrow X(s) \exp(-st_0)$

The ROC remain unchanged



# PROPERTIES: SHIFTING IN THE $s$ DOMAIN

---

- **Shifting in the  $s$  domain**

- If  $x(t) \leftrightarrow X(s)$

$$\operatorname{Re}(s) > \sigma$$

- Then  $y(t) = x(t) \exp(s_0 t) \leftrightarrow X(s - s_0)$

$$\operatorname{Re}(s) > \sigma + \operatorname{Re}(s_0)$$

- **Example**

- Find the Laplace transform of  $x(t) = A \exp(-at) \cos(\omega_0 t) u(t)$

# PROPERTIES: TIME SCALING

---

- **Time scaling**

- If  $x(t) \leftrightarrow X(s)$   $\text{Re}\{s\} > \sigma_1$

- Then  $x(at) \leftrightarrow \frac{1}{a} X\left(\frac{s}{a}\right)$   $\text{Re}\{s\} > a\sigma_1$

- **Example**

- Find the Laplace transform of  $x(t) = u(at)$

## PROPERTIES: DIFFERENTIATION IN TIME DOMAIN

- **Differentiation in time domain**

- If  $g(t) \leftrightarrow G(s)$

- Then  $\frac{dg(t)}{dt} \leftrightarrow sG(s) - g(0^-)$

$$\frac{d^2 g(t)}{dt^2} \leftrightarrow s^2 G(s) - sg(0^-) - g'(0^-)$$

$$\frac{d^n g(t)}{dt^n} \leftrightarrow s^n G(s) - s^{n-1} g(0^-) - \dots - sg^{(n-2)}(0^-) - g^{(n-1)}(0^-)$$

- **Example**

- Find the Laplace transform of  $g(t) = \sin^2 \omega t \cdot u(t)$ ,  $g(0^-) = 0$

## PROPERTIES: DIFFERENTIATION IN TIME DOMAIN

---

- **Example**

- Use Laplace transform to solve the differential equation

$$y''(t) + 3y'(t) + 2y(t) = 0, \quad y(0^-) = 3 \quad y'(0^-) = 1$$

## PROPERTIES: DIFFERENTIATION IN S DOMAIN

---

- **Differentiation in s domain**

- If  $x(t) \leftrightarrow X(s)$

- Then

$$(-t)^n x(t) \leftrightarrow \frac{d^n X(s)}{ds^n}$$

- **Example**

- Find the Laplace transform of  $t^n u(t)$

# PROPERTIES: CONVOLUTION

---

- **Convolution**

- If  $x(t) \leftrightarrow X(s)$                        $h(t) \leftrightarrow H(s)$

- Then  $x(t) \otimes h(t) \leftrightarrow X(s)H(s)$

The ROC of  $X(s)H(s)$  is the intersection of the ROCs of  $X(s)$  and  $H(s)$

# PROPERTIES: INTEGRATION IN TIME DOMAIN

---

- **Integration in time domain**

- If  $x(t) \leftrightarrow X(s)$

- Then  $\int_0^t x(\tau) d\tau \leftrightarrow \frac{1}{s} X(s)$

- **Example**

- Find the Laplace transform of  $r(t) = tu(t)$

# PROPERTIES: CONVOLUTION

---

- **Example**

- Find the convolution  $rect\left(\frac{t-a}{2a}\right) \otimes rect\left(\frac{t-a}{2a}\right)$



# PROPERTIES: CONVOLUTION

---

- **Example**

- For a LTI system, the input is  $x(t) = \exp(-2t)u(t)$ , and the output of the system is

$$y(t) = [\exp(-t) + \exp(-2t) - \exp(-3t)]u(t)$$

Find the impulse response of the system

# PROPERTIES: CONVOLUTION

---

- **Example**

- Find the Laplace transform of the impulse response of the LTI system described by the following differential equation

$$2y''(t) - 3y'(t) + y(t) = 3x'(t) + x(t)$$

assume the system was initially relaxed (  $y^{(n)}(0) = x^{(n)}(0) = 0$  )

# PROPERTIES: MODULATION

---

- **Modulation**

- If  $x(t) \leftrightarrow X(s)$

- Then  $x(t) \cos(\omega_0 t) \leftrightarrow \frac{1}{2} [X(s + j\omega_0) + X(s - j\omega_0)]$

- $x(t) \sin(\omega_0 t) \leftrightarrow \frac{j}{2} [X(s + j\omega_0) - X(s - j\omega_0)]$

# PROPERTIES: MODULATION

---

- **Example**

- Find the Laplace transform of  $x(t) = \exp(-at) \sin(\omega_0 t) u(t)$

# PROPERTIES: INITIAL VALUE THEOREM

---

- **Initial value theorem**

- If the signal  $x(t)$  is infinitely differentiable on an interval around  $x(0^+)$  then

$$x(0^+) = \lim_{s \rightarrow \infty} sX(s)$$

$s = \infty$  must be in ROC

- The behavior of  $x(t)$  for small  $t$  is determined by the behavior of  $X(s)$  for large  $s$ .

# PROPERTIES: INITIAL VALUE THEOREM

---

- **Example**

- The Laplace transform of  $x(t)$  is

- Find the value of  $x(0^+)$

$$X(s) = \frac{cs + d}{(s - a)(s - b)}$$

# PROPERTIES: FINAL VALUE THEOREM

- **Final value theorem**

- If  $x(t) \leftrightarrow X(s)$

- Then:  $\lim_{t \rightarrow \infty} x(t) \leftrightarrow \lim_{s \rightarrow 0} sX(s)$

$s = 0$  must be in ROC

- **Example**

- The input  $x(t) = Au(t)$  is applied to a system with transfer function  $H(s) = \frac{c}{s(s+b)+c}$ , find the value of  $\lim_{t \rightarrow \infty} y(t)$

# PROPERTIES

1. Linearity	$\sum_{n=1}^N \alpha_n x_n(t)$	$\sum_{n=1}^N \alpha_n X_n(s)$
2. Time shift	$x(t - t_0)u(t - t_0)$	$X(s) \exp(-st_0)$
3. Frequency shift	$\exp(s_0 t)x(t)$	$X(s - s_0)$
4. Time scaling	$x(\alpha t), \alpha > 0$	$1/\alpha X(s/\alpha)$
5. Differentiation	$dx(t)/dt$	$s X(s) - x(0^-)$
6. Integration	$\int_{0^-}^t x(\tau) d\tau$	$\frac{1}{s} X(s)$
7. Multiplication by $t$	$t x(t)$	$-\frac{dX(s)}{ds}$
8. Modulation	$x(t) \cos \omega_0 t$	$\frac{1}{2} [X(s - j\omega_0) + X(s + j\omega_0)]$
	$x(t) \sin \omega_0 t$	$\frac{1}{2j} [X(s - j\omega_0) - X(s + j\omega_0)]$
9. Convolution	$x(t) * h(t)$	$X(s)H(s)$
10. Initial value	$x(0^+)$	$\lim_{s \rightarrow \infty} s X(s)$
11. Final value	$\lim_{t \rightarrow \infty} x(t)$	$\lim_{s \rightarrow 0} s X(s)$



# OUTLINE

---

- Introduction
- Laplace Transform
- Properties of Laplace Transform
- **Inverse Laplace Transform**
- Applications of Fourier Transform

# INVERSE LAPLACE TRANSFORM

---

- **Inverse Laplace transform**

$$x(t) = \frac{1}{2\pi j} \int_{\sigma-j\infty}^{\sigma+j\infty} X(s) \exp(st) ds$$

- Evaluation of the above integral requires the use of contour integration in the complex plane → difficult.

- **Inverse Laplace transform: special case**

- In many cases, the Laplace transform can be expressed as a rational function of  $s$

$$X(s) = \frac{b_m s^m + b_{m-1} s^{m-1} + \dots + b_1 s + b_0}{a_n s^n + a_{n-1} s^{n-1} + \dots + a_1 s + a_0}$$

- Procedure of Inverse Laplace Transform
  - 1. Partial fraction expansion of  $X(s)$
  - 2. Find the inverse Laplace transform through Laplace transform table.

# INVERSE LAPLACE TRANSFORM

---

- **Review: Partial Fraction Expansion with non-repeated linear factors**

$$X(s) = \frac{A}{s - a_1} + \frac{B}{s - a_2} + \frac{C}{s - a_3}$$

$$A = (s - a_1)X(s)\Big|_{s=a_1} \quad B = (s - a_2)X(s)\Big|_{s=a_2} \quad C = (s - a_3)X(s)\Big|_{s=a_3}$$

- **Example**

– Find the inverse Laplace transform of  $X(s) = \frac{2s + 1}{s^3 + 3s^2 - 4s}$

# INVERSE LAPLACE TRANSFORM

---

- **Example**

- Find the Inverse Laplace transform of

$$X(s) = \frac{2s^2}{s^2 + 3s + 2}$$

- If the numerator polynomial has order higher than or equal to the order of denominator polynomial, we need to rearrange it such that the denominator polynomial has a higher order.

# INVERSE LAPLACE TRANSFORM

---

- Partial Fraction Expansion with repeated linear factors

$$X(s) = \frac{1}{(s-a)^2(s-b)} = \frac{A_2}{(s-a)^2} + \frac{A_1}{s-a} + \frac{B}{s-b}$$

$$A_2 = (s-a)^2 X(s) \Big|_{s=a} \quad A_1 = \frac{d}{ds} \left[ (s-a)^2 X(s) \right] \Big|_{s=a} \quad B = (s-b)X(s) \Big|_{s=b}$$

# INVERSE LAPLACE TRANSFORM

---

- High-order repeated linear factors

$$X(s) = \frac{1}{(s-a)^N (s-b)} = \frac{A_1}{s-a} + \frac{A_2}{(s-a)^2} + \cdots + \frac{A_N}{(s-a)^N} + \frac{B}{s-b}$$

$$A_k = \frac{1}{(N-k)!} \left. \frac{d^{N-k}}{ds^{N-k}} \left[ (s-a)^N X(s) \right] \right|_{s=a} \quad k = 1, \dots, N$$

$$B = (s-b)X(s) \Big|_{s=b}$$

# OUTLINE

---

- Introduction
- Laplace Transform
- Properties of Laplace Transform
- Inverse Laplace Transform
- **Applications of Laplace Transform**

## APPLICATION: LTI SYSTEM REPRESENTATION

- **LTI system**

- System equation: a differential equation describes the input output relationship of the system.

$$y^{(N)}(t) + a_{N-1}y^{(N-1)}(t) + \cdots + a_1y^{(1)}(t) + a_0y(t) = b_Mx^{(M)}(t) + \cdots + b_1x^{(1)}(t) + b_0x(t)$$

$$y^{(N)}(t) + \sum_{n=0}^{N-1} a_n y^{(n)}(t) = \sum_{m=0}^M b_m x^{(m)}(t)$$

- S-domain representation

$$\left[ s^N + \sum_{n=0}^{N-1} a_n s^n \right] Y(s) = \left[ \sum_{m=0}^M b_m s^m \right] X(s)$$

- Transfer function

$$H(s) = \frac{Y(s)}{X(s)} = \frac{\sum_{m=0}^M b_m s^m}{s^N + \sum_{n=0}^{N-1} a_n s^n}$$



## APPLICATION: LTI SYSTEM REPRESENTATION

- Simulation diagram (first canonical form)

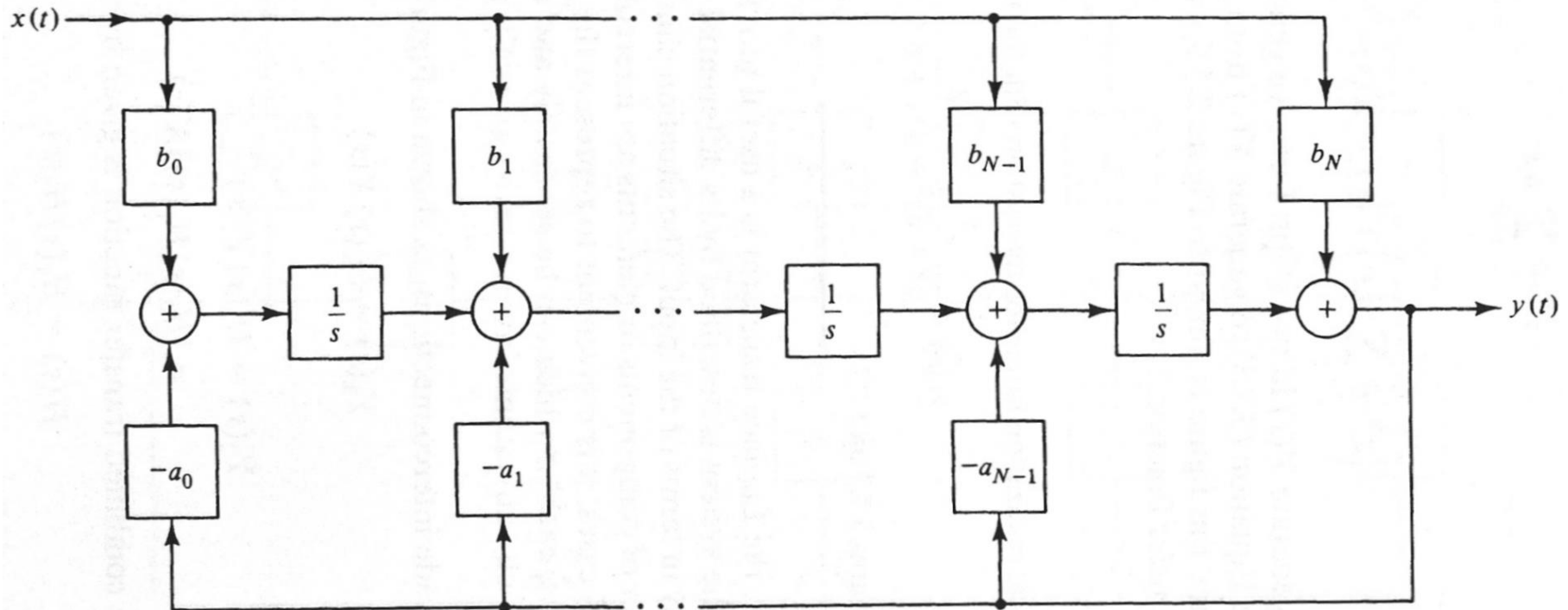

## APPLICATION: LTI SYSTEM REPRESENTATION

---

- **Example**

- Show the first canonical realization of the system with transfer function

$$H(S) = \frac{s^2 - 3s + 2}{s^3 + 6s^2 + 11s + 6}$$

# APPLICATION: COMBINATIONS OF SYSTEMS

- **Combination of systems**

- Cascade of systems

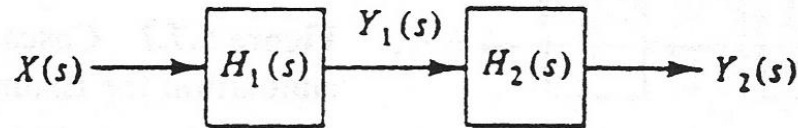

$$H(S) = H_1(s)H_2(s)$$

- Parallel systems

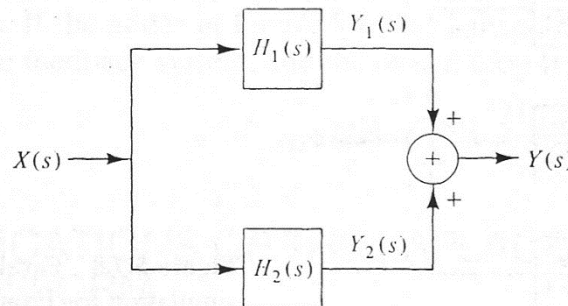

$$H(S) = H_1(s) + H_2(s)$$

## APPLICATION: LTI SYSTEM REPRESENTATION

---

- **Example**

- Represent the system to the cascade of subsystems.

$$H(S) = \frac{s^2 - 3s + 2}{s^3 + 6s^2 + 11s + 6}$$

## APPLICATION: LTI SYSTEM REPRESENTATION

- **Example:**
  - Find the transfer function of the system

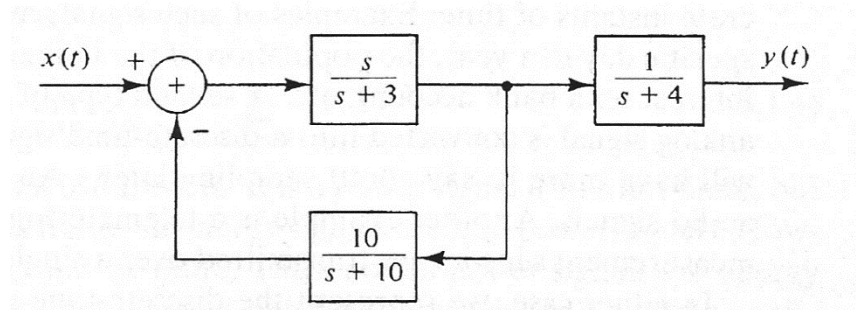

## APPLICATION: LTI SYSTEM REPRESENTATION

---

- Poles and zeros

$$H(s) = \frac{(s - z_M)(s - z_{M-1}) \cdots (s - z_1)}{(s - p_N)(s - p_{N-1}) \cdots (s - p_1)}$$

- Zeros:  $z_1, z_2, \dots, z_M$
- Poles:  $p_1, p_2, \dots, p_N$

# APPLICATION: STABILITY

---

- **Review: BIBO Stable**

- Bounded input always leads to bounded output

$$\int_{-\infty}^{+\infty} |h(t)| dt < \infty$$

- **The positions of poles of  $H(s)$  in the s-domain determine if a system is BIBO stable.**

$$H(s) = \frac{A_1}{s - s_1} + \frac{A_2}{(s - s_2)^m} + \dots + \frac{A_N}{s - s_N}$$

- Simple poles: the order of the pole is 1, e.g.  $s_1$   $s_N$
- Multiple-order poles: the poles with higher order. E.g.  $s_2$

# APPLICATION: STABILITY

- Case 1: simple poles in the left half plane

$$\frac{1}{(s - \sigma_k)^2 + \omega_k^2} = \frac{1}{(s - \sigma_k + j\omega_k)(s - \sigma_k - j\omega_k)} \quad \sigma_k < 0$$

$$p_1 = \sigma_k - j\omega_k$$

$$p_2 = \sigma_k + j\omega_k$$

$$h_k(t) = \frac{1}{\omega_k} \exp(\sigma_k t) \sin(\omega_k t) u(t)$$

$$\int_{-\infty}^{+\infty} |h_k(t)| dt =$$

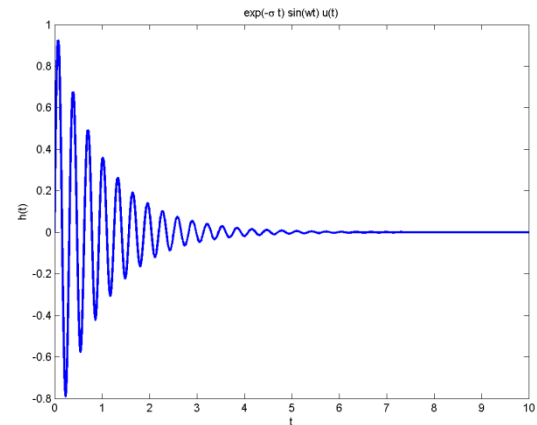

- If all the poles of the system are on the left half plane, then the system is stable.



# APPLICATION: STABILITY

- **Case 2: Simple poles on the right half plane**

$$\frac{1}{(s - \sigma_k)^2 + \omega_k^2} = \frac{1}{(s - \sigma_k + j\omega_k)(s - \sigma_k - j\omega_k)} \quad \sigma_k > 0$$

$$p_1 = \sigma_k + j\omega_k$$

$$p_2 = \sigma_k - j\omega_k$$

$$h_k(t) = \frac{1}{\omega_k} \exp(\sigma_k t) \sin(\omega_k t) u(t)$$

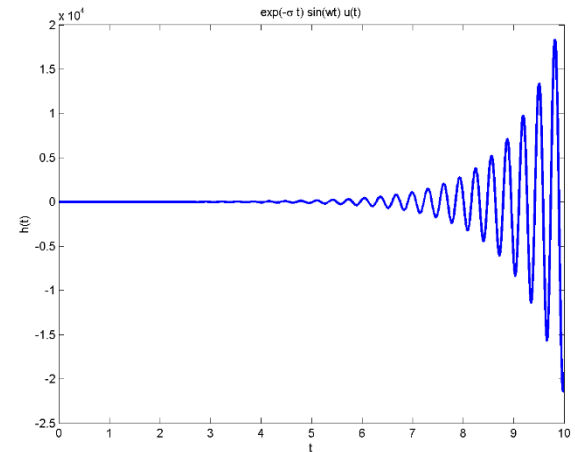

- **If at least one pole of the system is on the right half plane, then the system is unstable.**

## APPLICATION: STABILITY

---

- **Case 3: Simple poles on the imaginary axis**

$$\frac{1}{(s - \sigma_k)^2 + \omega_k^2} = \frac{1}{(s - \sigma_k + j\omega_k)(s - \sigma_k - j\omega_k)} \quad \sigma_k = 0$$

$$h_k(t) = \frac{1}{\omega_k} \sin(\omega_k t) u(t)$$

- **If the pole of the system is on the imaginary axis, it's unstable.**

# APPLICATION: STABILITY

- **Case 4: multiple-order poles in the left half plane**

$$h_k(t) = \frac{1}{\omega_k} t^m \exp(\sigma_k t) \sin(\omega_k t) u(t) \quad \sigma_k < 0 \quad \text{stable}$$

- **Case 5: multiple-order poles in the right half plane**

$$h_k(t) = \frac{1}{\omega_k} t^m \exp(\sigma_k t) \sin(\omega_k t) u(t) \quad \sigma_k > 0 \quad \text{unstable}$$

- **Case 6: multiple-order poles on the imaginary axis**

$$h_k(t) = \frac{1}{\omega_k} t^m \sin(\omega_k t) u(t) \quad \text{unstable}$$

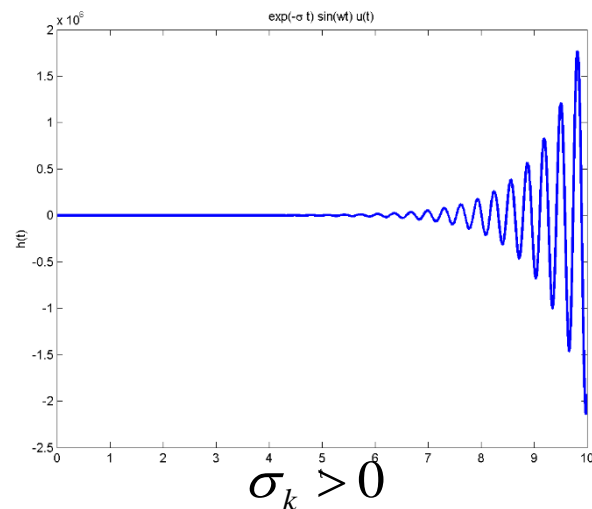
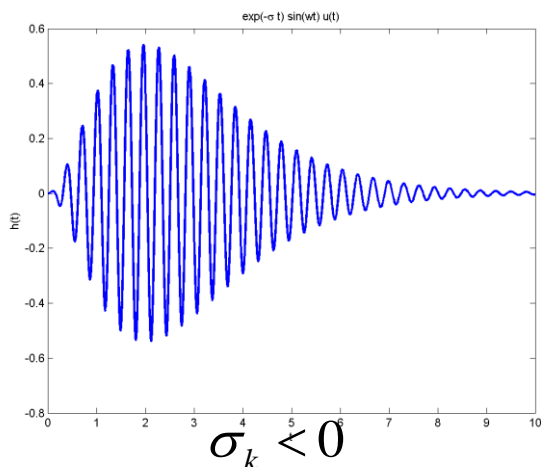

# APPLICATION: STABILITY

---

- **Example:**

- Check the stability of the following system.

$$H(s) = \frac{3s + 2}{s^2 + 6s + 13}$$